

Article number: 2301072712
 Description: E+G Handwheel
 VDS.125+IR-A14

Measures

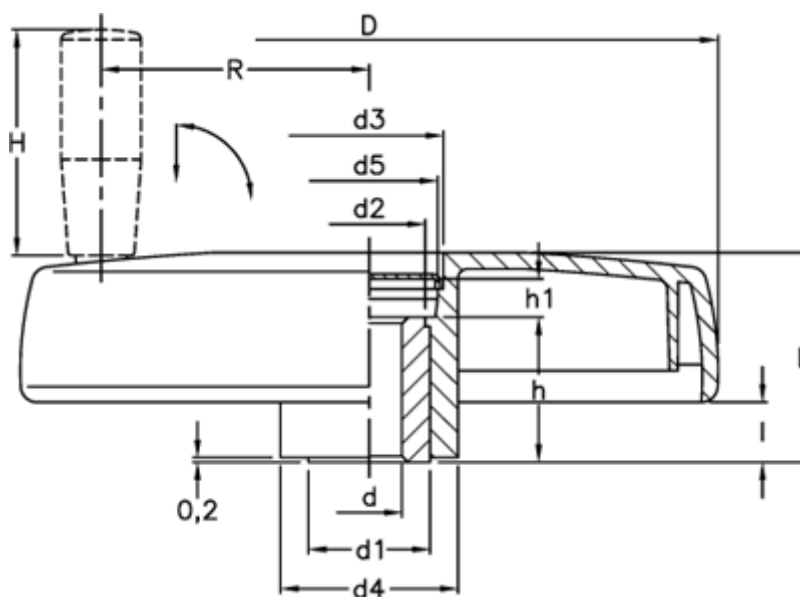

C (N m)	= 125	H	= 56
D	= 125	h	= 27
d1	= 26	h1	= 8.0
d2	= 24.0	l	= 11.0
d3	= 31.0	L	= 39
d4	= 35	L (J)	= 14
d5	= 28.0	R	= 49
d H7	= 14		